

Article number: 29560512993225
 Description: Shaft mounted gear
 A512H50-129,9-P71B5

Measures

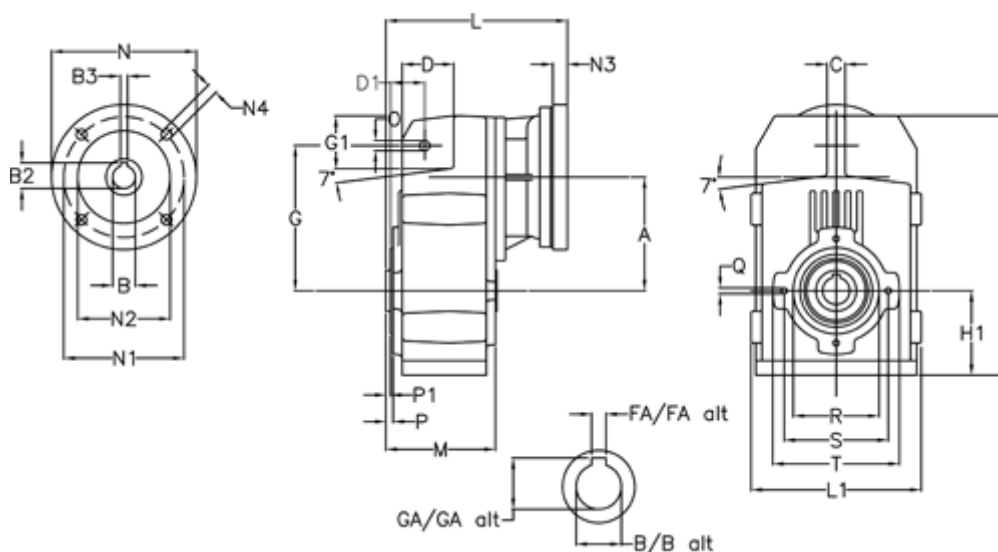

A = 211.30	FA = 14	M = 163.0	Q = M12x19
B = 50	G = 278	N = 160	R = 180
B1 = 14	G1 = 105.5	N1 = 130	S = 215
B2 = 16.3	GA = 53.5	N2 = 110	T = 250
B3 = 5	H = 479.0	N4 = M8x16	
C = 20	H1 = 144.0	O = 22	
D = 93.5	L = 268.0	P = 8.5	
D1 = 65.0	L1 = 273	P1 = 4.5	